

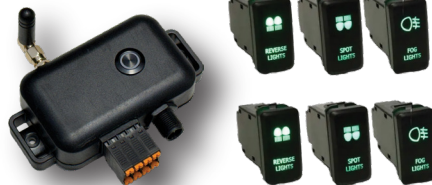

STAR RANGE

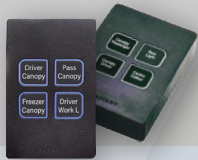
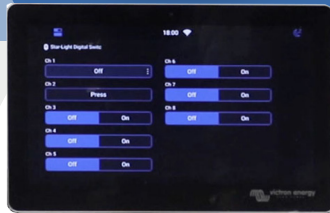
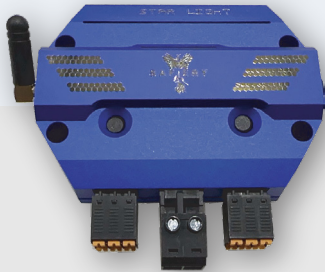
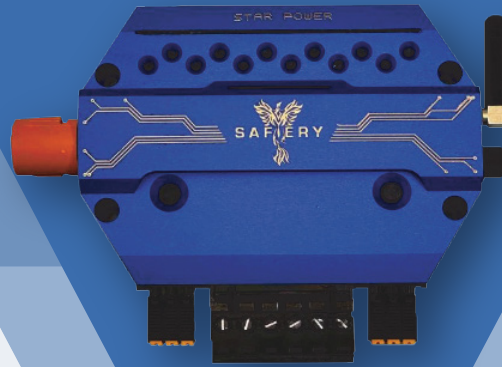

V2.4

DESIGNED AND MADE IN AUSTRALIA
DELIVERED TO THE WORLD TODAY

WWW.SAFIERY.COM



UK Reseller:
www.bladesolutions.co.uk



CONTENT

AI Automatic Configurator	1
Introduction	6
Product Range and Spec	10
Security of Data	12
Safety	14
STAR-LIGHT Description	15
STAR-Power Description	16
STAR-Rover Description	17
STAR- Switch Custom Description	18
STAR- Switch Description	20
Electrical Basics of Digital Switching	21
Suggested Channel Choices	22
Programming	23
Select Communication Components	25
Programming Channels	26
Programming Single Channels	27
Programming DUAL Channels	28
Programming RGBW	29
Programming CAN Keypads	30
Programming BLUETOOTH Switches	31
Firmware Update OTA (Over The Air)	32
CAN Wiring - A Practical Reference Guide	33
CAN Wiring - Quality Waterproof NMEA Connections	38
Instantly Compatible: Apple, Google and Samsung	39
Support	41

STARSHIP – The Family of STAR Controllers and Switches

All rights reserved. No parts of this work may be reproduced in any form or by any means - graphic, electronic, or mechanical, including photocopying, recording, taping, or information storage and retrieval systems - without the written permission of the publisher.

Products that are referred to in this document may be either trademarks and/or registered trademarks of the respective owners. The publisher and the author make no claim to these trademarks.

While every precaution has been taken in the preparation of this document, the publisher and the author assume no responsibility for errors or omissions, or for damages resulting from the use of information contained in this document or from the use of programs and source code that may accompany it. In no event shall the publisher and the author be liable for any loss of profit or any other commercial damage caused or alleged to have been caused directly or indirectly by this document.

Important Notice for Installation in Vehicles

The STAR Range of Products are designed for installation in the rear of vehicles, motorhomes, vans and caravans. They are not to be installed in the engine bay. Please make installation less than 2m from the floor.



UK Reseller:
www.bladesolutions.co.uk

BLADE
SOLUTIONS

Star Power and Star Light contains sharp edges and should not be touched without taking care.

© 2025 This document is Copyright of Publisher who is Bruce Loxton

AI Automatic configurator is available online at <https://ai.safiery.com>

See image templates below. Watch the video to see exactly how to use. In Q4 2025, we are migrating this configurator to integrate with our eCommerce platform.

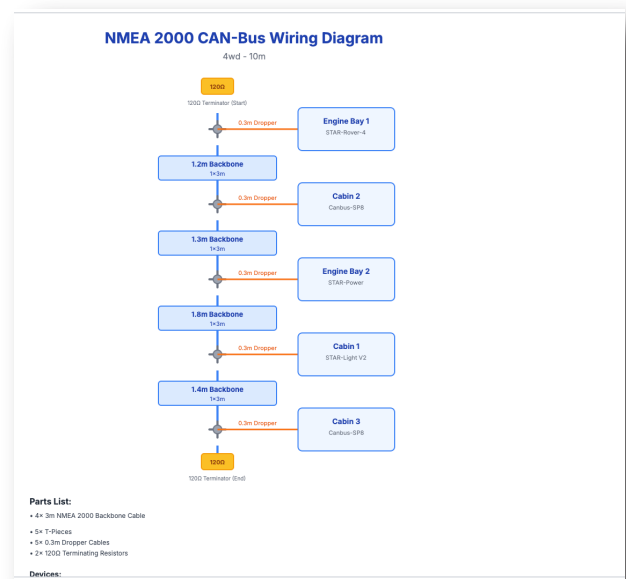
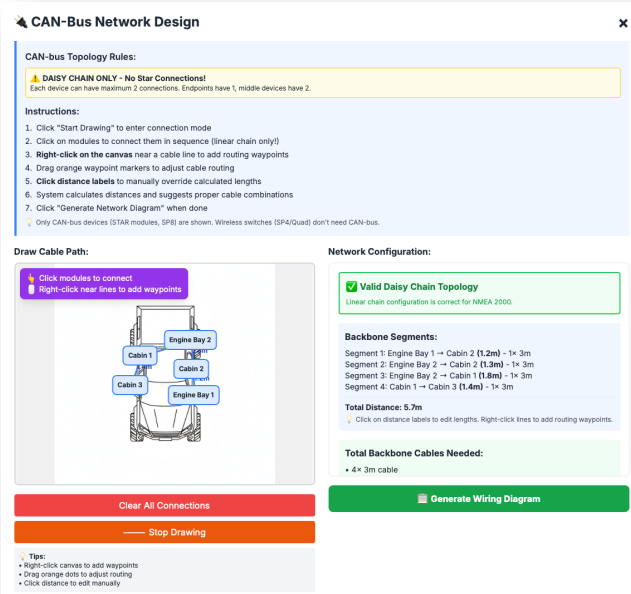
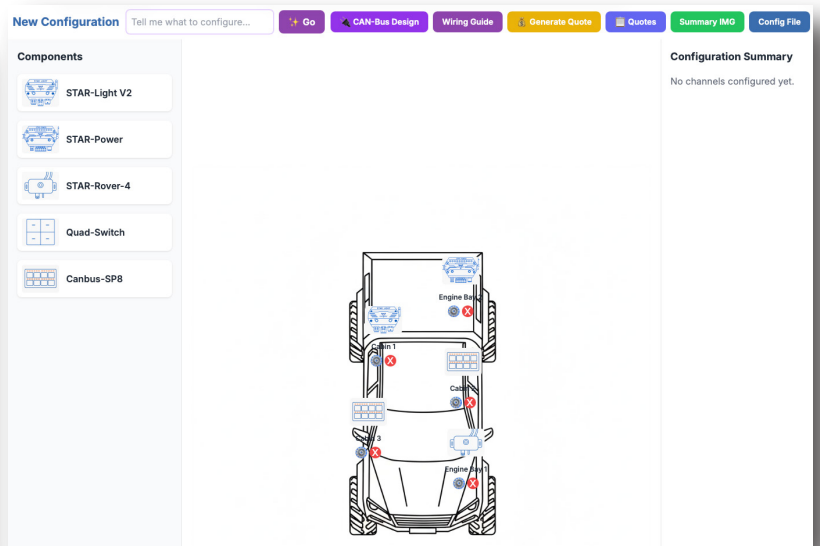
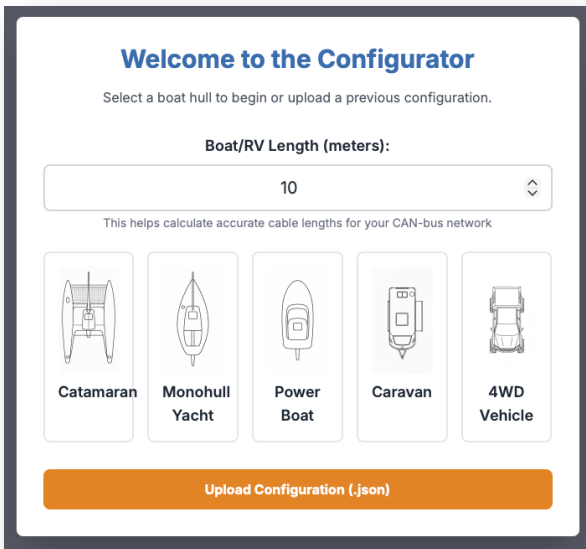

UK Reseller:
www.bladesolutions.co.uk



Watch Video Above

Cabin 1 - Configuration

Ch	Custom Name	Function	Polarity	Fuse Rating
1	Channel 1	Not Set	(+) Positive	N/A
2	Channel 2	Not Set	(+) Positive	N/A
3	Channel 3	Not Set	(+) Positive	N/A
4	Channel 4	Not Set	(+) Positive	N/A
5	Channel 5	Not Set	(+) Positive	N/A
6	Channel 6	Not Set	(+) Positive	N/A
7	Channel 7	Not Set	(+) Positive	N/A
8	Channel 8	Not Set	(+) Positive	N/A
9	Channel 9	Not Set	(+) Positive	N/A
10	Channel 10	Not Set	(+) Positive	N/A
11	Channel 11	Not Set	(+) Positive	N/A
12	Channel 12	Not Set	(+) Positive	N/A

Done

System Wiring Guide

Okay, here's a comprehensive wiring guide for your 4WD setup, incorporating the Safiery STAR range products, based on the official product manual and your specific configuration. This guide prioritizes safety and ease of installation.

Safiery STAR Digital Switching Wiring Guide for 4WD

This guide is tailored for your setup, which includes:

- Cabin 1•• STAR-Light-V2
- Engine Bay 1•• STAR-Rover-4
- Engine Bay 2•• STAR-Power
- Cabin 2•• CANbus-SP8
- Cabin 3•• CANbus-SP8

I. Safety First!

- Disconnect Power•• Before starting any wiring, disconnect the main battery negative terminal to prevent accidental shorts.
- Fusing•• Always use appropriate fuses as specified in the manual (see "Safety" section of the manual). Pay close attention to the maximum fuse sizes for each controller.
- Grounding•• Ensure all ground connections are secure and connected to a common ground point (chassis or battery negative).
- Wire Size•• Use appropriately sized wiring for the current draw of each circuit, referring to the manual's recommendations.
- Read the Manual•• This guide is based on the official Safiery manual. Refer to the manual for detailed specifications and safety information.
- Professional Installation•• If you are not comfortable with electrical work, consult a qualified marine electrician.

Copy to Clipboard

Edit Quote #1761629259250

Quote Name: catamaran Digital Switching System Customer Name: E.g., John Smith

Boat Name: catamaran Notes: Generated from configurator. Boat length: 10m

Linked Configuration
Configuration saved: catamaran - 5 components

Open in Configurator View Diagrams

Line Items

SKU	Description	Qty	Unit Price	Total	Action
STAR-power-Matter-150	STAR-Power	2	\$924.00	\$1848.00	
STAR-light-MATTER	STAR-Light V2	1	\$890.00	\$890.00	
STAR-Switch-SP8	Canbus-SP8	2	\$204.75	\$409.50	
010-11076-01	NMEA Cable 5m	4	\$55.00	\$220.00	
010-11078-00	NMEA T-Connector	5	\$39.00	\$195.00	
010-11076-03	NMEA Dropper 0.3m	5	\$39.00	\$195.00	
NMEA-Terminator-Pair	NMEA Terminator Pair	1	\$25.00	\$25.00	
NMEA-vecan-joiner-1	NMEA VE-CAN Kit	1	\$282.10	\$282.10	

Subtotal: \$4064.60

Save Quote Download PDF Convert to Invoice

System Wiring Guide

B. STAR-Rover-4 (Engine Bay 1)

- Power Input••
 - Connect the positive and negative cables to the appropriate terminals on the STAR-Rover.
 - Cable Size•• Use at least 6mm² cable.
 - Fuse•• Install a 50A fuse on the positive power wire near the battery.
- Channel Outputs••
 - STAR-Rover can switch both positive and negative circuits.
 - Negative Switched Circuits•• Connect the positive wire of the device to a fused positive source. Connect the negative wire of the device to the corresponding STAR-Rover channel output.
 - Positive Switched Circuits•• Connect the negative wire of the device to a common negative ground. Connect the positive wire of the device to the corresponding STAR-Rover channel output.
- RGBW Wiring••
 - If using RGBW lights, wire as follows (using Negative Switching as noted above):
 - Channel 1: Red
 - Channel 2: Green
 - Channel 3: Blue
 - Channel 4: White

C. STAR-Power (Engine Bay 2)

- Power Input••
 - Connect the positive and negative cables to the appropriate terminals on the STAR-Rover.
 - Cable Size•• Use at least 16mm² cable.

Copy to Clipboard

UK Reseller:
www.bladesolutions.co.uk



Instructional Videos will be added here. Our Plan is to follow this manual.

Instructional Videos will be added here. Our Plan is to follow this manual.

STARSHIP™ is the name of a family of digital switching products that interact with each other for:

- Easy to install system
- Easy to expand and add to
- Significantly reduced installation costs.
- Easy to program from a Smartphone
- Highest Blockchain Security



Using OPEN Protocols and OPEN wireless standards gives you:

- 20+ year system life expected as it's NOT proprietary communication
- Core use of IPv6 endpoints gives ultra-long term "service life"
- If Matter is enabled, then open interconnectivity to hundreds of devices using your smartphone

There is no "Hub" nor "master" in this STARSHIP™ network which:

- Reduces entry level cost to a few hundred dollars.
- Switches link directly to each controller independently giving redundancy
- Easy to add devices, no need to reprogram entire system, just the "add-ons"

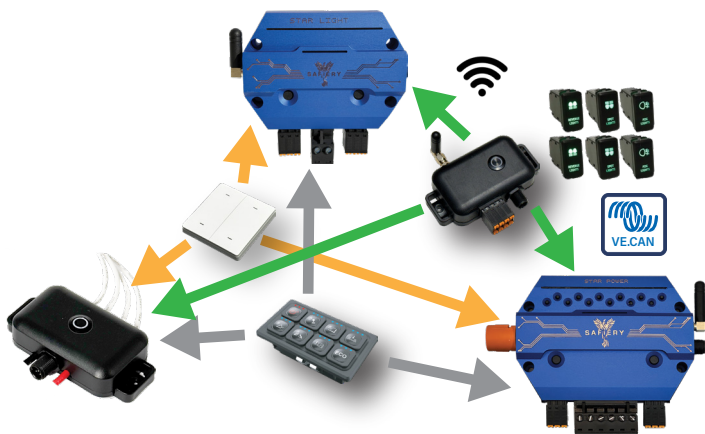

- Switches Communicate direct to Controller
- No "Hub" in the Middle
- CAN Keypad and/or Bluetooth to same output
- Bluetooth Switching now with NMEA and/or SAE
- Up to 6 switches to one output
- Integrates fully traditional individual switches

Collaboration with larger systems is at it's core

- Victron Energy integration to STAR range
- NMEA compliant Multi-function Displays can control directly including these Brands:



Wireless range that is Huge

- Large STAR controllers have external antenna for 100m line of sight. 40m in typical installs
- Large STAR controllers have external antenna for 100m line of sight. 40m in typical installs

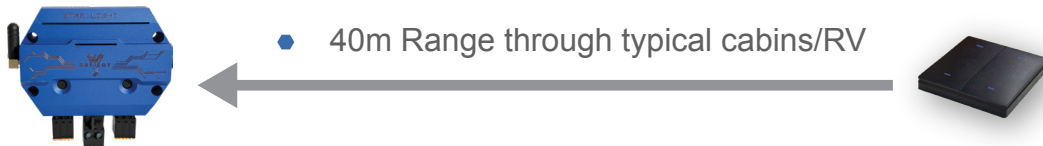

SAE (Society of Automotive Engineers) compliant J1939 devices can be configured to control:

- CAN Keypads and Switches
- Many others



Safety for the Do-It-Yourself Users:

- Exclusively use “Infineon” power devices on circuit board
- Use of hardware protection for digital output circuits that “open circuit” in 80 millionths of a second
- Grounded aluminium anodised case
- Protects against short circuits in 80 millionths of a second - NO FUSE NEEDED

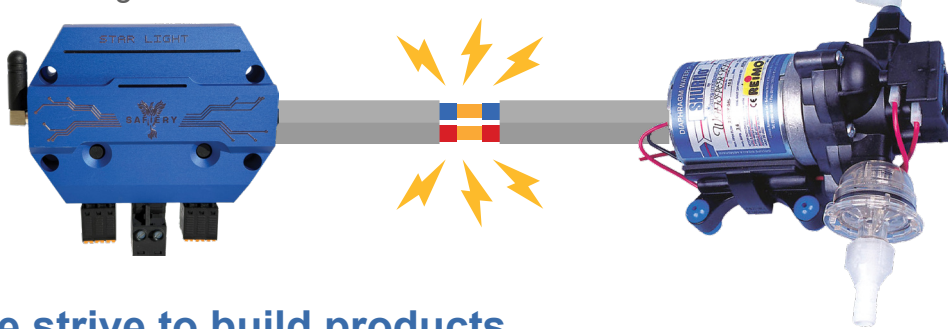

Finally, we strive to build products

- “Beautiful to the eye”
- Extremely Compact
- Longest Service Life possible.

If you are interested to the back story on STARSHIP, it starts in 2001 in Sweden at Ericsson.

Go here to the story
[“Slaying the Dragon to save the Princess”](#)

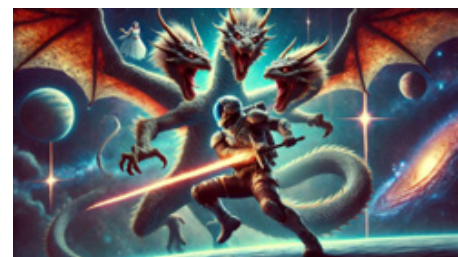

UK Reseller:
www.bladesolutions.co.uk



Switching Functionality and Advanced Programming Concepts

Touch Screen (Victron or STAR-Touch)

These screens do in software what is described above. They send either a CAN message from the Victron Cerbo or an encrypted message on WiFi. Whilst this may seem more complex, it isn't really as the programs to do this are industry standards with years of development. They are robust and reliable. Just like your smartphone.

The screens mimic the states of the STAR controllers when switched by the Bluetooth or CAN.



Advanced Programming Concepts

Master and Sub Master Programming

By reserving a button on the Bluetooth switch and/or a CAN keypad as a master and using it every time as a switch point for each channel, you easily create a master on/off switch.

Sub-master switches can be created the same way.

Using Switch inputs for logic control is continued on next page.

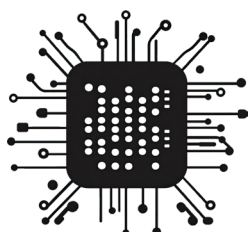

UK Reseller:
www.bladesolutions.co.uk



SAFIERY

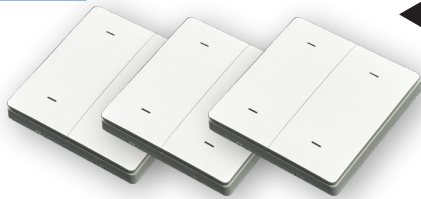

Up to 80 Wireless Wall Switches
Double Press Colour Change



STAR Switch Custom - Unlimited Logic Blocks
Wired and outputs from other STAR Controllers
6 wire Inputs - momentary or toggle or latched



Keypads CAN wired
interchangeable custom icons



Now in 24V
Digital Switching
& Dimming Controllers

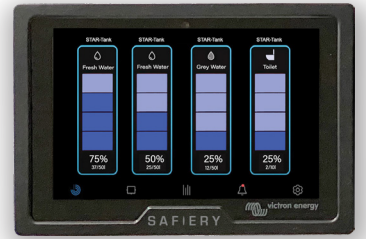

Wireless Tank Level



Wireless Temperature





Victron Integration is ONE Cable Plug and Play- Watch 24s Video

UK Reseller:
www.bladesolutions.co.uk

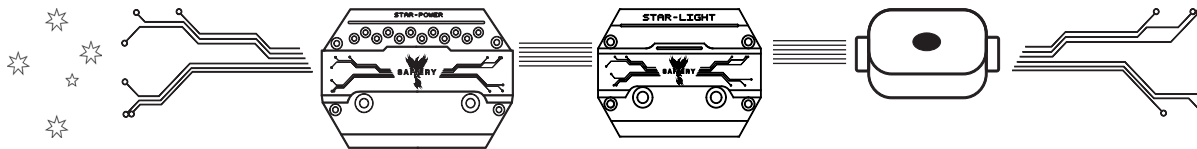

Award Winning STAR Controller Range



"Let the Stars guide your path"	STAR-Power**	STAR-Light	STAR-Rover
Channels	6 x 30A 6 x 10A Dimmable	12 x 10A Dimmable Incl 2 x RGBW	4 x 15A Dimmable Incl 1 x RGBW
Max Current	100A	40A	40A
Construction	Aluminium Anodised	Aluminium Anodised	ABS Plastic
Voltage range	10-32V	10-32V	10-32V
Open Circuit Cut Off	Advanced Fuseless: 80 millionth second hardware protection		
CAN Ports	1 x CAN Port NMEA Connector 2nd CAN Port	1 x CAN Port NMEA Connector	1 x CAN Port NMEA Connector
Bluetooth	Bluetooth Long Range Antenna	Bluetooth Long Range Antenna	Bluetooth Long Range Antenna
Backup Buttons on Face	Yes	No	No
Dual channels control	Yes, by double press on any Switch		
Channel Polarity choices	All Positive	Any channel can be assigned as Positive or Negative control	
No of Switch buttons Control each channel	Up to 6 switch buttons can be configured as modes, master, sub-master		
Programmed by	Smartphone App, Press for WiFi access point mode		
 victron energy BLUE POWER	Can be controlled by upcoming digital switch screen on Cerbo		
Install Height	Less than 2m from Ground (safety - no ladder needed to instal)		
Dimensions	160 x 120 x 28mm	140 x 110 x 28mm	70 x 55 x 22mm

SAFIERY

EXPLORE THE STAR - SWITCH RANGE

STAR-TANK

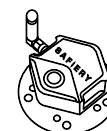
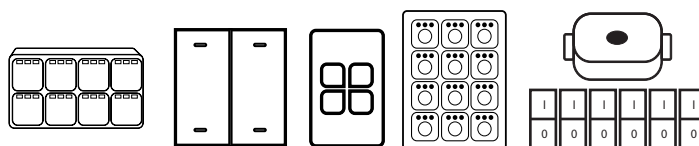

SWITCH DIRECT TO CONTROLLER - NO HUB - ALL INDEPENDENT

UK Reseller:
www.bladesolutions.co.uk



Product Range and Spec

Award Winning STAR Switch Range

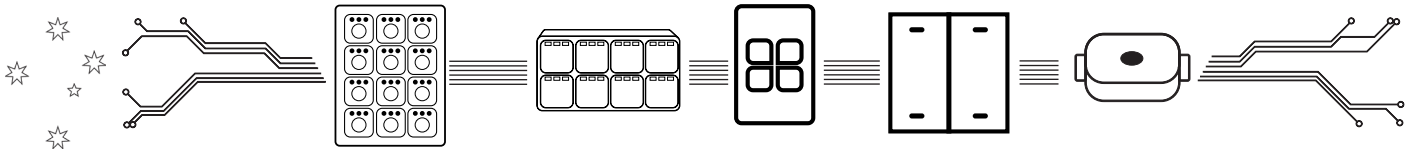

"Switch on the STARS"	STAR-Switch IC (8 or 12)	STAR-Switch SP8	STAR-Switch SP4	STAR-Switch Wall	STAR-Switch Custom
Buttons	8 or 12 tactile	8 tactile	4 tactile	4 tactile	6 wired Inputs
Communication	CAN	CAN	Bluetooth	Bluetooth	CAN & Bluetooth
Powered	12V	12V	CR2032 Battery	CR2032 Battery	12V
Construction	ABS, Back-lit	Rubber Back-lit	ABS	ABS	ABS
Orientation	Landscape or Portrait	Landscape	Portrait	Square	Hidden
Customisation	Interchangeable Buttons Can be custom engraved	Custom Engraved	Custom Engraved	Custom Engraved	Inputs are either 12V or switched to Ground
Dual channels control	Yes, double press on any Switch button for control of second channel				
Programmed by	No Programming necessary				Smartphone
		Can be used in parallel with upcoming digital switch screen on Cerbo			
IP Rating	IP65	IP67	IP22	IP22	IP54
Dimensions	8 Button: 106-61-9mm (34mm behind) 12 Button: 106-84-9mm (34mm behind)	105-63-16mm (22mm behind)	94-60-2mm (8mm behind)	85-85-2mm (8mm behind)	70-55-22mm Plug on side

SAFIERY

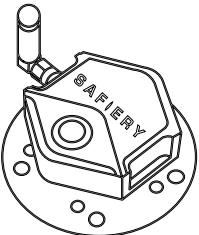

STAR-TANK

- Phased Coherent Radar
- Bluetooth to Victron
- Sits on Top Tank
- Tank Level
- Battery 3-5yr
- Up to 2,000mm deep
- Fresh Water
- 40m range
- Non-Metal / Carbon Fibre
- Grey Water
- Indication on LED
- SAE 5 Hole for Fuel(500mm)
- Black Water
- 60 sec sample rate
- Metal Plate under



Wireless with temperature sensor on board for freeze detection

UK Reseller:
www.bladesolutions.co.uk



* STAR-Switch Wall and STAR-Switch SP4 contain lithium battery CR2032, these products are not suitable for use in locations where children are likely to be present.

* Replacement of a battery with an incorrect type that can defeat a safeguard (for example in the case of some lithium battery types);

* Disposal of a battery into fire or a hot oven, or mechanically crushing or cutting of a battery, that can result in an explosion;

* Leaving a battery in an extremely high temperature surrounding environment that can result in an explosion or the leakage of flammable liquid or gas; and

* A battery subjected to extremely low air pressure that may result in an explosion or the leakage of flammable liquid or gas.

Wireless range

If you are in your forties or older, you probably have had poor experiences with wireless.

The simple wall button wireless switching in caravans uses older garage door opening technology and we have heard many stories of lights coming on unintentionally in a large caravan park; likely triggered by adjacent users. Plus early experiences with Bluetooth connectivity had very poor range.

Wireless range performance has changed progressively. There is no “sudden moment” with an increase in wireless range. It just got better and better as the technology improved. Both the Bluetooth and WiFi is 100m line of sight. Our testing of wireless from 40m away reading and writing from sensors and switches inside a full enclosed Airstream aluminium caravan was faultless.

Wireless Security

I hope you like reading big numbers!

For STAR Bluetooth devices, there are 340 undecillion (or approximately 3.4×10^{38}) possible unique Wireless UUIDs in Bluetooth. That is 2 to the 128 power = this number:

340,282,366,920,938,463,463,374,607,431,768,211,456

This ensures that UUIDs are uniquely assigned without risk of duplication.

For STAR Controllers with IPV6 endpoints, the uniquely assigned endpoints are the same:

So, there are 340 undecillion (approximately 3.4×10^{38}) possible IPV6 addresses. This vast number of addresses ensures that IPV6 can provide unique addresses for a nearly unlimited number of devices.

When a switch is programmed, the STAR controller will ONLY accept a signal from the UUID of that switch after it is programmed. No other Bluetooth device will be read and used. Other Bluetooth signals are filtered out.

Blockchain Security of STAR controllers with Matter

The security of blockchain encryption has decentralization, immutability, and cryptographic guarantees which focus on privacy and secure communication for smart IOT devices.

When we look out 5-10 years from now, security of data is paramount. It will become the number one requirement:

- Image or video security of data is required for privacy. It will be available with blockchain security from 2026.
- Traditional power systems with a single point of secure access will be too vulnerable and too “old School”
- The combination of blockchain encryption with the Matter protocol provides a **highly secure, decentralized, and privacy-focused ecosystem** for smart devices. This architecture offers a superior security model for IoT ecosystems, addressing many of the risks associated with centralized systems, such as single points of failure, data manipulation, and privacy violations.

UK Reseller:
www.bladesolutions.co.uk

BLADE
SOLUTIONS

Why Blockchain Encryption with Matter Protocol is Essential for 20+ years of Long Service Life

- Enhanced Device Authentication and Integrity:** Blockchain's decentralized nature and cryptographic integrity checks can add an extra layer of security for authenticating devices in the Matter ecosystem. Blockchain can store verified public keys and cryptographic hashes of Matter device firmware, ensuring that devices are not tampered with and have legitimate software.
- Immutable Record of Actions:** Blockchain can be used to record important actions and communications within the Matter ecosystem, such as device state changes or user commands. This would allow for an immutable, transparent audit trail of interactions, making it easier to trace back to potential security breaches and provide accountability.
- Protection Against Centralized Attacks:** Blockchain's decentralized approach protects the system from a single point of failure or centralized attack, which is a major vulnerability in many traditional smart home ecosystems.
- Autonomous and Trustless System:** The combination of blockchain with Matter means devices do not need to trust a central authority to verify their interactions. Blockchain's consensus mechanisms ensure that only verified, authenticated data is processed, creating a more robust and secure system.
- Privacy:** The use of blockchain protects users' privacy while still providing security, especially in an RV or Boat setting where sensitive data might otherwise be exposed to those close by.

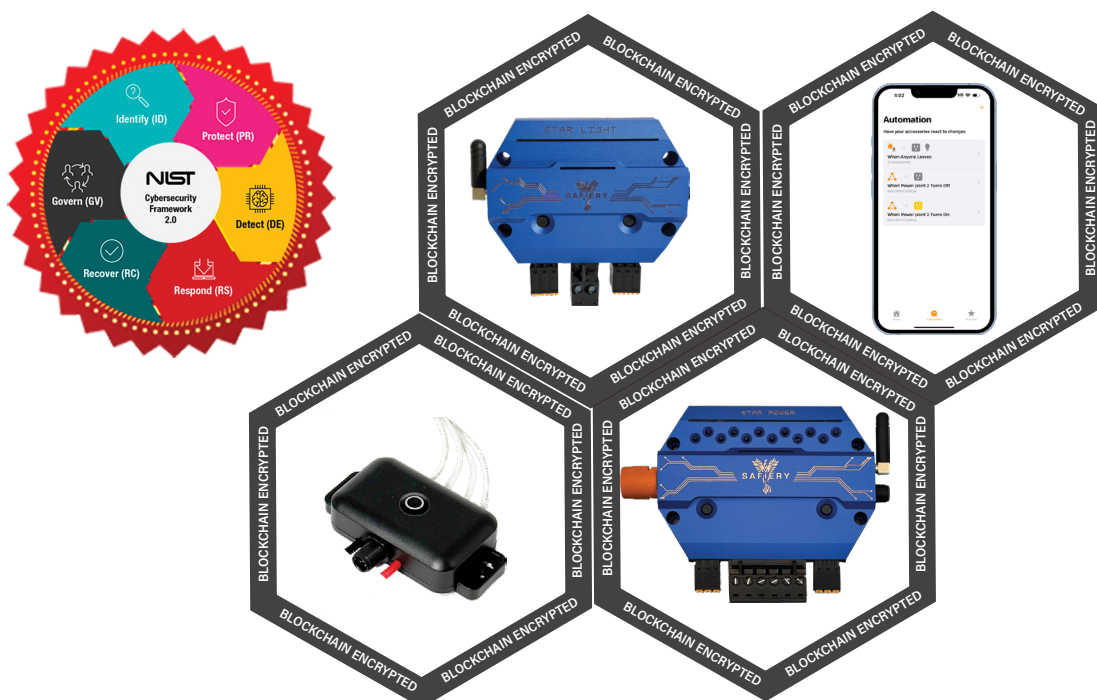

UK Reseller:
www.bladesolutions.co.uk



Fusing of Power to Devices

	STAR-Power	STAR-Light	STAR-Rover	STAR-Switch Custom
Minimum Power Wire Size	16mm ²	8mm ²	6mm ²	2.5mm ²
Maximum Fuse Size	150A	50A	50A	10A

The STAR Controller ONLY controls one “leg” of the circuit. Generally positive power but can be configured as negative outputs for STAR-Light and STAR-Rover.

For positive output Switching the return negative circuit goes directly to ground or Battery Negative. The return circuits **MUST NOT BE CONNECTED TO THE NEGATIVE WIRE OF THE STAR CONTROLLERS DIRECTLY OR THE CONTROLLERS WILL NOT FUNCTION.**

If Switching/Dimming Negative circuits, the positive leg to these circuits **MUST BE FUSED INDEPENDENTLY AND GO TO BATTERY POSITIVE AND NOT TO THE STAR CONTROLLER.** STAR controller will protect the power on the negative leg.

ALWAYS connect the Ground Wire in the Plug first before powering up

STAR-LIGHT Description

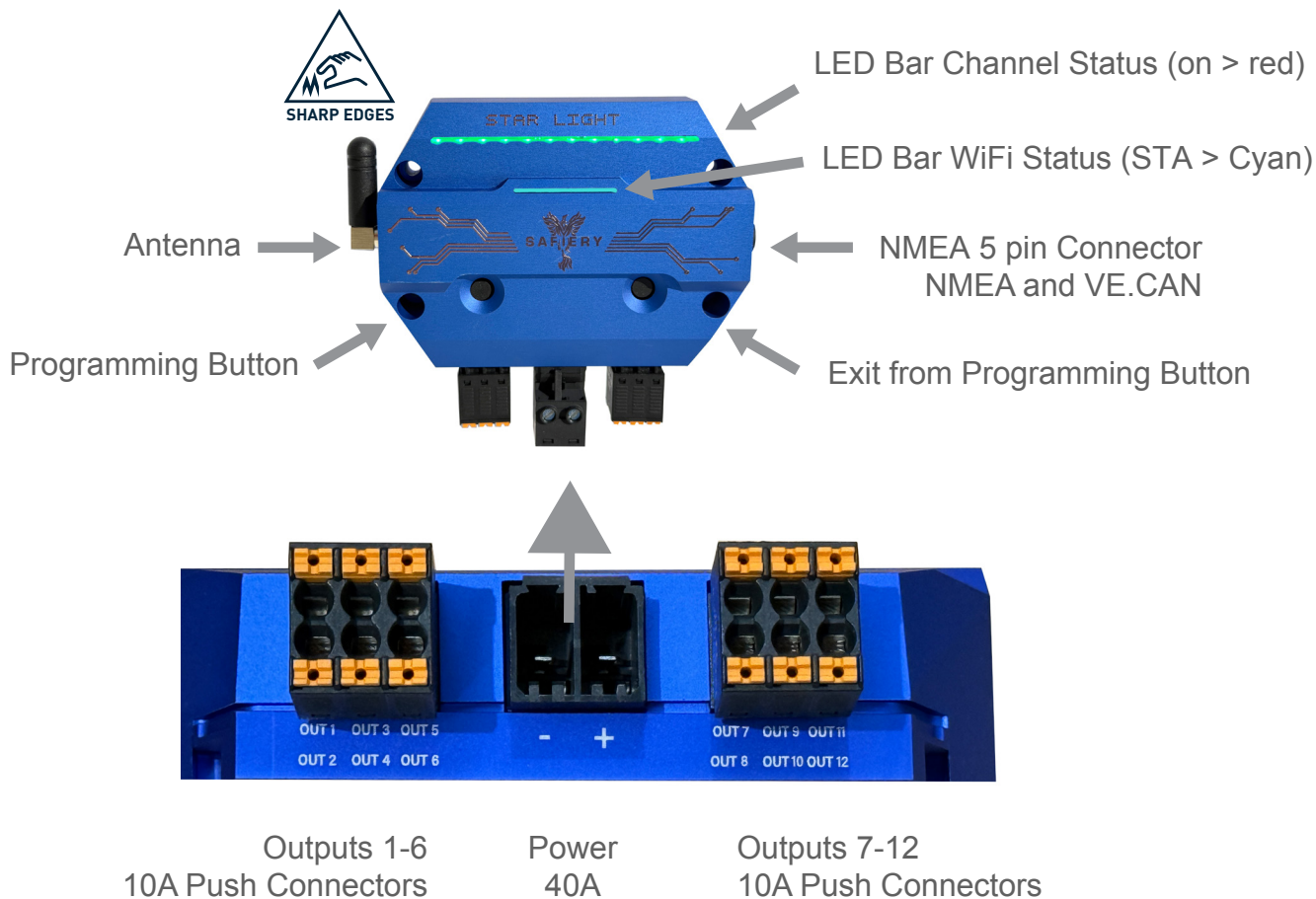

Outputs Can be Positive + Switch/Dim OR Negative Switch/Dim

This very unique feature of either positive or negative selection on any channel gives the ultimate in installer flexibility.

High end LED's and generally dual colour LED strips that alternate colours along the strip are negatively switches and dimmed. RGBW LEDs are always negatively dimmed and switched.

Individual LED's can then be positively dimmed and switch. Just install all the LED's and change the channel setting when you program. Its that easy.

RGBW LED's - up to TWO

Set your colour using the Smartphone. Toggle between All White or Colour with double press of switches.

For a RGBW light, R (red), G (green), B (blue), and W (white) are connected to channel 1, 2, 3, and 4, respectively. Similar to another RGBW channel 9, 10, 11, and 12.

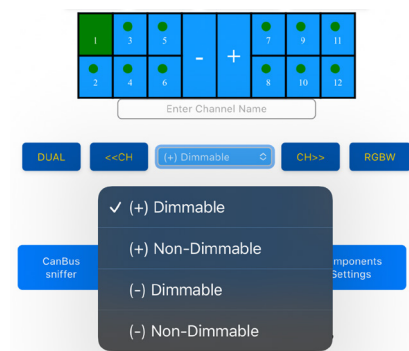

RGB Color Selection

	Stored	Updating
Red	255	255
Green	0	0
Blue	130	130
White	0	0

Update Color

UK Reseller:
www.bladesolutions.co.uk



STAR-Power Description

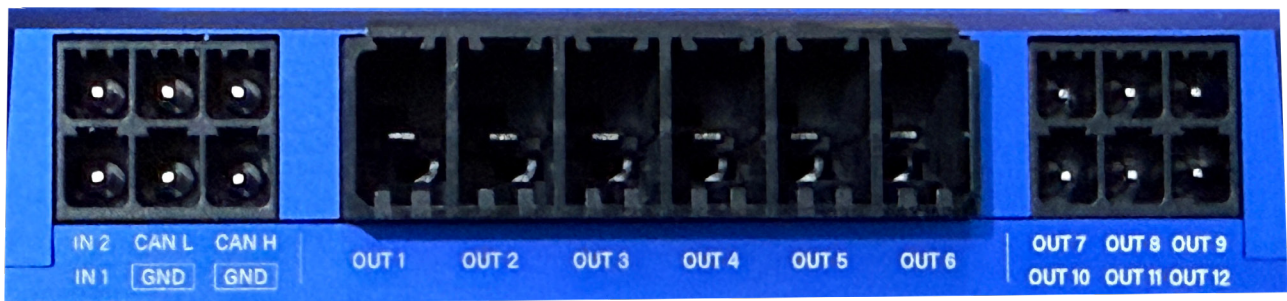
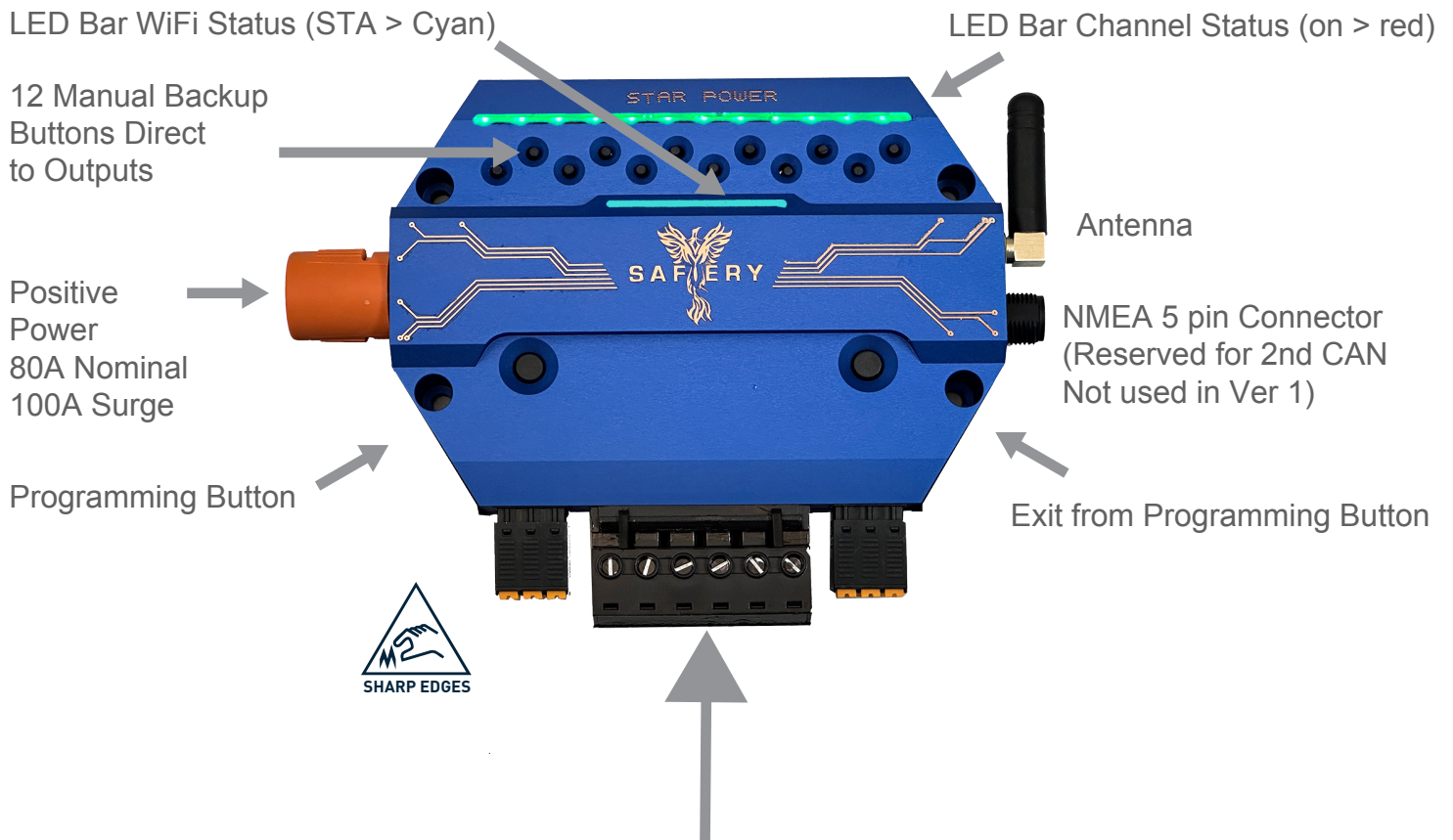

2 Wired Inputs
CAN L and CAN H
NMEA and VE.CAN
Two ground Inputs
(for redundancy)

Power Connectors
Channel 1-6
30A Each

Dimmable Outputs 7-12
10A Push Connectors

Positive Power ONLY. Negative Wires go to Ground or Battery Negative. They DO NOT return to the controller.

10A channels are dimmable.

Backup buttons direct drive outputs overriding software commands.

STAR-Rover Description

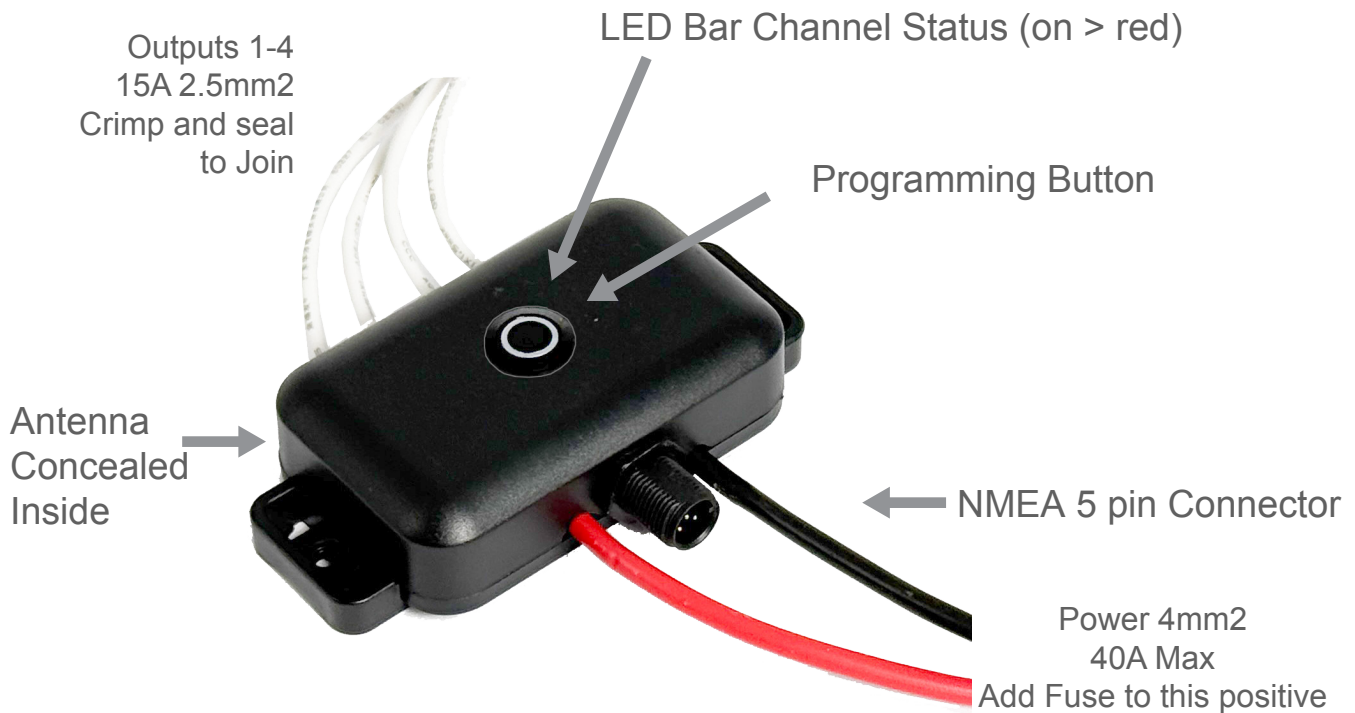

Outputs Can be Positive + Switch/Dim OR Negative Switch/Dim

This very unique feature of either positive or negative selection on any channel gives the ultimate in installer flexibility.

High end LED's and generally dual colour LED strips that alternate colours along the strip are negatively switches and dimmed. RGBW LEDs are always negatively dimmed and switched.

Individual LED's can then be positively dimmed and switch. Just install all the LED's and change the channel setting when you program. Its that easy.

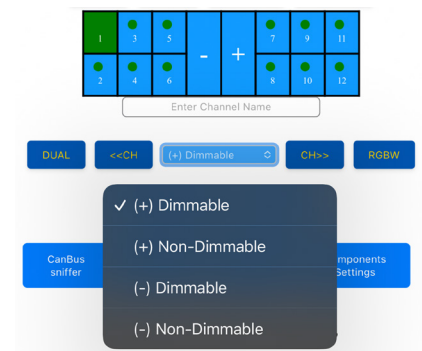

RGBW LED's - One uses all 4 Channels

Set your colour using the Smartphone. Toggle between All White or Colour with double press of switches.

For a RGBW light, R (red), G (green), B (blue), and W (white) are connected to channel 1, 2, 3, and 4, respectively. Similar to another RGBW channel 9, 10, 11, and 12.

RGB Color Selection

	Stored	Updating
Red	255	255
Green	0	0
Blue	130	130
White	0	0

Update Color

UK Reseller:
www.bladesolutions.co.uk



STAR-Switch Custom Description

STAR-Switch Custom opens up endless opportunities for the clever 4WD users and OEMs.

This device has 6 inputs and CAN and Bluetooth plus WiFi outputs. Think of it as a “controller in reverse”

Independent switches that the user supplies are connected to the 6 inputs. They can be activated by 12V high (LED on your switch comes on) or by switching to ground.

This device has 6 inputs and CAN and Bluetooth plus WiFi outputs. Think of it as a “controller in reverse”

Independent switches that the user supplies are connected to the 6 inputs. They can be activated by 12V high (LED on your switch comes on) or by switching to ground.

Each Input can be programmed independently to be:

Momentary or Latched inputs (momentary is a press to activate switch, latched is a on/off switch)
From these 6 inputs there is a logic feature set of 6 logic blocks. The output of each logic block will activate a single command as a “Switch on/off” command to a STAR controller.

The Logic options are:

- And
- Nand (Not and)
- Or (only 2 inputs)
- NOR (not or) (only 2 inputs)



UK Reseller:
www.bladesolutions.co.uk



The Logic block can have up to 6 of the switch inputs with one logic state of AND or NAND.

This allows users and OEMS to:

- Have an automatic interlock when ignition key is one to turn devices on/off
- Have an interlock for Spot-lights or reversing lights when an input permits.

We have an accessory that reads most vehicle CAN busses and is programmed to activate and output based on even more logic or vehicle speed or engine RPM.

It is an optional purchase.

- If 2 free pins are used from the trailer connecting plug, then notification if the plug comes out
- Interlocks for canopy doors, awnings, steps, water pumps, beds that raise... the list goes on.
- For Safety logic, always connect STAR-Switch Custom using CAN communication with NMEA cabling rather than wireless.

Programming STAR Switch Custom

1) Press the Front Button for 10 secs. The Colour Changes to Blue
Once you see deep blue release the button.

2) Go to Phone settings and select "WiFi"

Release current WiFi from "always join" and turn WiFi off then on if you are currently on WiFi.
On iPhone , turn off Mobile Data as it will drag WiFi connectivity to an internet accessible WiFi channel and not STAR controller.

Now access the SSID that starts with "STARCUSTOM". Then enter the password shown on the device. "Starcustom@0"

The go to browser and enter 172.24.24.1

You should now see the programming page.

On your smartphone save this page to "Home Screen" on iPhone or phone on Android.

3) Your browser now looks like this:

At the Top is the Firmware Version Followed by the MAC ID fir 4 letters (This is on outside of unit)

STAR-Switch Description

Bluetooth Switch

When a button is pressed, the switch broadcasts to all controllers using its unique UUID address.

Those controllers that are programmed to listen for this wireless address (see security why no other wireless device can impersonate this) and turn on/off or dim the output channel corresponding to the switch command. The Switch retains in memory it's status.



CAN Based 8 button or 12 button Switch

When a button is pressed, the switch sends a CAN or NMEA message to the network of all controllers using its unique CAN ID and Button ID address.

Those controllers that are programmed to listen for this CAN ID address turn on/off or dim the output channel corresponding to the switch command. The beauty of CAN communication is there is NO HUB nor MASTER CONTROLLER and the message can be read by multiple devices with the highest security. The message is returned to the keypad and the LED associated with the button that was pressed lights up. CAN Keypad LEDs light up for the corresponding button even if the associated channel is turned on by bluetooth.



Dual channel Programming from One Switch

A standard feature on all controllers is "Dual Channel" mode. When this is selected during programming, it means a single press on a switch (Bluetooth or CAN) will select the first channel, a second press will select the second channel, a third press will select both channels. The common application is dual colour switching when both colours are in the one LED. If this is white and amber then the colour when both is selected is a beautiful golden colour that can be dimmed if the LED is dimmable. In other applications, the first channel is floor lights and the second channel is ceiling lights, Double press to get one or other or both.



Press Once for White

Press Twice for Amber

Press Again for both Colours



UK Reseller:
www.bladesolutions.co.uk

BLADE
SOLUTIONS

Positive Switched and Dimmed Circuits

If you are in your forties or older, you probably have had poor experiences with wireless.

Positive polarity switching is the most common form of digital switching. The output from the controller to the wired device becomes a positive 12Volts when turned on and zero voltage when turned off. The other wire from the device is connected to battery negative. Best practice is to also always have all negatives to a common chassis ground. If you have wired this way then only one positive wire goes to the device and the other wire goes to chassis ground. NEVER connect his “other wire” back to a STAR controller.

Dimming positive circuits simply reduces the effective voltage at the LED which dims the LED.

Negative Switched and Dimmed Circuits

Negative polarity switching is common with high quality dimmable LED’s, particularly LED strips or rolls. The output from the controller to the wired device Connects the LED to zero volt battery negative or ground when turned on. The other wire from the device is connected to battery 12V positive and must be fused independently. NEVER connect his “other positive wire” back to a STAR controller.

Dimming negative circuits simply increases the effective voltage at the LED on the negative side reducing the difference between the 12V positive and the negative voltage which dims the LED. A potential problem with lots of negatively dimmed LEDs is that the ground becomes "noisy" due to switching—can interfere with other electronics.

STAR-Switch Custom Circuits

Up to 6 inputs from third party switches or other devices can be wired into this device.

Each input is configured as:

1. 12V positive (or high) input generally turning on an LED when activated on the independent switch itself. In this case the input is called positive high. The input can be a latched switch or ignition wire or similar or a momentary input from a push button. The input is configured as “latched or Momentary”
2. Wire input that is switched to Zero voltage or ground. Typically these inputs are door switches or alarm switch inputs as no fusing of the wire is needed. The input can be a latched switch or ignition wire or similar or a momentary input from a push button. The input is configured as “latched or Momentary”

Logic blocks can then applied to these inputs as described later in this manual.

Always use CAN communication from these switches to the STAR controllers when using logic and safety circuits.

Using Gas Strut Switches for Automatic canopy Door Opening On/Off

Generally use positively switched and dimmed LED lights and wire the negative return wire through the gas strut switch.

Suggested Channel Choices

	Items to be Switched	Suggested Channel configuration	Guide Notes
1	Single Colour LED Light	Any for STAR-Light or STAR-Rover on negative or positive channels. Only Positive for STAR-Power	Current per channels limited to 120W DO NOT USE FOR FRONT LIGHT BAR OR WORK LIGHTS > 120W Wire the first and second channel and test by selecting each channel and turning on and off on the app.
2	Front Light Bar	STAR-Power	Use 30A Channel of STAR-Power for lights > 120W but less than 400W.
3	Side Work Lights	As per item 1 if less then 120W.	Maximum power all lights on at same time is 40A on STAR-Light and STAR-Rover. 1800W on STAR-Power.
4	Rock Lights	As per item 1	
5	RGBW Light	As per RGBW Setup	Multiple RGBW strips can be combined provided the maximum load when all turn on is < 400W
6	Compressor Single Stage	STAR-Power	Use 30A Channel of STAR-Power for single compressor of 30A or less.
7	Compressor Dual Stage	STAR-Power or STAR-Light or STAR-Rover non dimmable channels	Common use is ARB Dual Stage which just activates a low power input remotely.
8	Water Pump	STAR-Power or STAR-Light or STAR-Rover non dimmable channels	Typically these are less than 10A and can be used of any STAR controller. If more than 10A then only on STAR-Power
9	Fridge	NEVER use any STAR controller, always wire direct to fridge. Jupiter has dedicated Anderson plug on rear for up to 3 fridges	Reason is there is too much risk someone accidentally turn fridge off on switch and ruins all the food.
10	Travel Buddy Oven	These are 15A so use 30A channel	
11	Fans	If these are less than 10A use any STAR controller. If more than this use 30A channel on STAR-Power	STAR-Rover is 15A
12	Other 12V devices that are not lights	If these are less than 10A use any STAR controller. If more than this use 30A channel on STAR-Power	STAR-Rover is 15A

UK Reseller:
www.bladesolutions.co.uk



STAR-Power

STAR-Power is ONLY positive switching.

STAR-Power has 6 x 30A non dimmable channels all +ve in the centre and 6 x 10A +ve dimmable with a max of 150A overall.

The 30A channels in the centre are ON/off only with no dimming. The 10A remaining channels are positive dimmable.

Program the Switches to activate these wire channels

There are 4 ways to activate the wired channels

1. Bluetooth Switches
2. CAN Keypads
3. STAR-Switch Custom Wired inputs
4. Touch Screens (Victron, STAR-Touch or others)

Multiple Button Assignments

You can assign up to 6 different buttons to a single channel.

Whilst you can do these in any order, the most productive way is to follow this guide.

In the template at the back of this manual write the wired channel number name across the top Down the page in each row right switch name and button number. For the 4 Bluetooth switches the convention we use is top row is 1,2 and bottom row is 3,4 from left to right. For CAN Keypads the convention is similar 1-4 across the top and 5-8 across the bottom. The 12 button keypad follows suite.

The if there is a master or sub master of if you are using logic with the STAR-Switch Custom wired inputs, write this into the rows. Then put a check box against the channel that will be activated. Once you have done this for all the switches, you are ready to program their activations.

The STAR controllers are programmed using WiFi NOT Bluetooth. Why? Because for remote programming in the secure block chain environment, only WiFi is accessible. It is also planned to have remote support including programming assistance and for that with the block chain security, it has to be done using WiFi.

1) Press the Left hand Button for 10 secs.

The Lower LED bar will change colour to deep blue as feedback that programming mode is active. Once you see deep blue release the button.

2) Go to Phone settings and select "WiFi"

Release current WiFi from "always join" and turn WiFi off then on if you are currently on WiFi. On iPhone , turn off Mobile Data as it will drag WiFi connectivity to an internet accessible WiFi channel and not STAR controller.

Now access the SSID that starts with "STAR-XXX". Then enter the password shown on the device. The go to browser and enter 172.24.24.1

You should now see the programming page.

On your smartphone save this page to "Home Screen" on iPhone or phone on Android.

3) Your browser now looks like this:

At the Top is the Firmware Version
Followed by the MAC ID fir 4 letters
(This is on outside of unit)

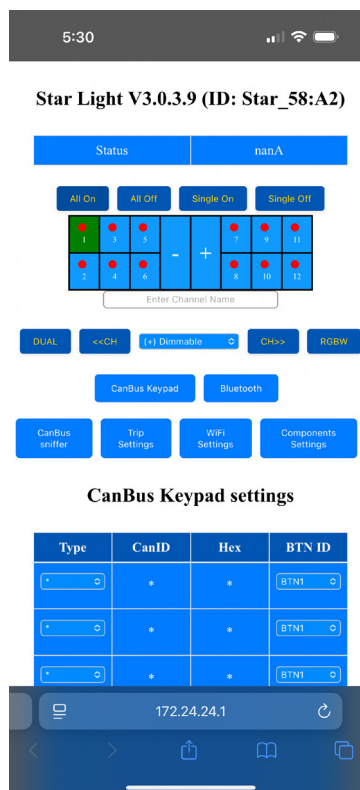

There are three Channel Types to select from before programming

1. Single Channel
2. Dual Channels
3. RGBW Channels

It is recommended to program these from 3 then 2 then 1 last.

Select Communication Components

Star Light V3.0.4.3(ID: Star_26:2E)

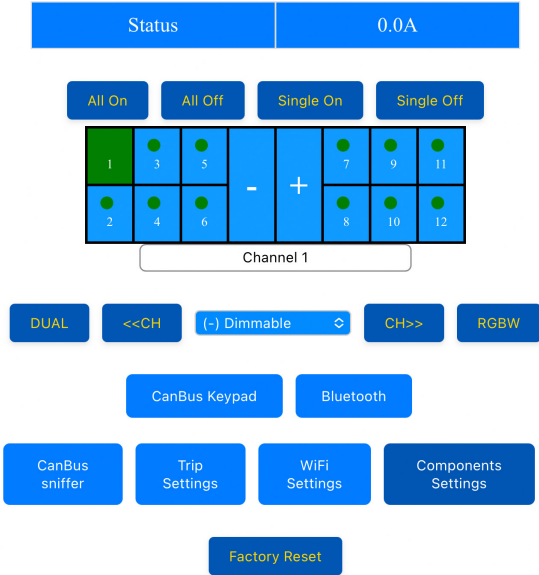

Component Settings

Component	State
Bluetooth (BLE)	<input checked="" type="checkbox"/>
CAN Bus	<input checked="" type="checkbox"/>
Matter	<input type="checkbox"/>
MQTT	<input checked="" type="checkbox"/>
NMEA 2000	<input checked="" type="checkbox"/>

Note: Changes to component settings will take effect after device restart.



ALL STAR Controllers

Scroll down toward the bottom of the page to see which services are to be enabled.

There are 5 communication services with your STAR Range of controllers which is especially unique to have so many services available with digital switching and control.

Note the CAN service applies to the CAN Keypads and J1939 compliant services and variations of it. NMEA is the Marine Variant of CAN and can co-exist on the same CAN network. Bother Victrons Cerbo GX and the Industry MFD's operate on the NMEA Network

In testing, all these services are enabled and the device will operate with all selected. The reason for deselecting those services you are not using for now is to increase the response time on those you do select. This is important if you have multiple STAR controllers in the system. You can always come back and enable a new service later when you are ready.

Special Note on the Matter Service. The Matter Software is already loaded in every device BUT Matter requires Blockchain encryption and this requires CPU's loaded with a Device Certificate. Safiery will release all three controllers with Matter in Q4 2025. Shipments before then will require the product to be returned to Safiery for the Device certificate to be loaded. It can't be done as an Over The Air Update.

Enable the Services you are using.

- BLUETOOTH is needed for Switches and generally always enabled
- CAN Communication - needed for CAN Keypads and Vehicle J1939 interface devices
- MATTER Protocol - needed once Matter is released. It layers "over the top" of the other services.
- MQTT Communication - needed for STAR AI products, RANGE MASTER AI, STAR-Drive AI
- NMEA 2000 needed for Victron Integration and NMEA communication

Pay attention to the "Restart Device" which is needed after changes are made.

UK Reseller:
www.bladesolutions.co.uk



Programming Channels



Star Light V3.0.3.9 (ID: Star_58:A2)

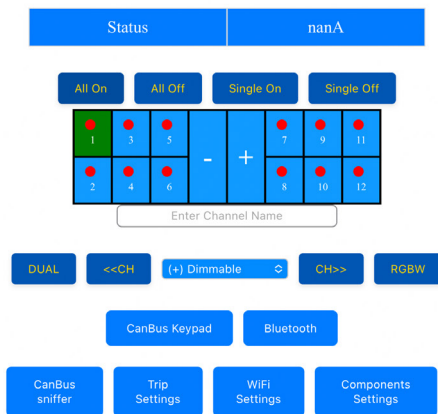

CanBus Keypad settings

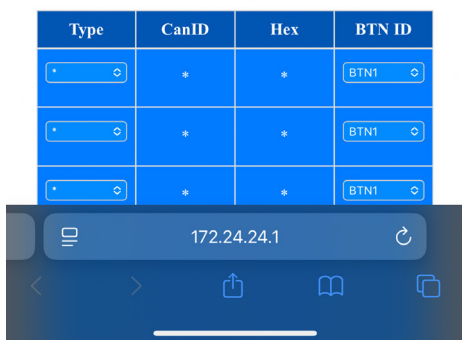

Programming is done in two parts:

1. Program the connected wired channels
2. Program the Switches to activate these wire channels

It HAS to be done in this order.

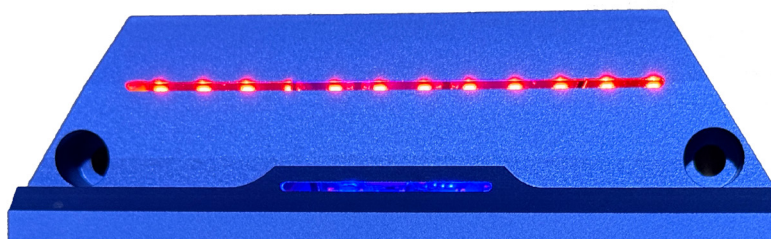

There is a selection for each Channel of:

- + Dimmable
- + Non Dimmable
- Dimmable
- Non Dimmable

These match the physical device or LED you are switching

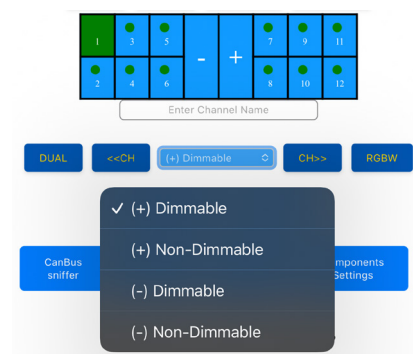

Programming Wired Channels

STAR-Light and STAR-Rover

STAR-Light has 12 x 10A channels either +ve or -ve with 8 dimmable and a max of 40A overall. STAR-Rover has 4 x 15A channels either +ve or -ve with 4 dimmable and a max of 40A overall.

(Image below is STAR-Light – STAR-Rover is similar but only 4 channels)



These channels represent the wiring position on the Phoenix plugs. For STAR-Light the first 4 and last 4 channels are dimmable. Channel 5,6,7,8 are not dimmable. For STAR-Rover all 4 channels are dimmable.

The Green “dot” means the channel is turned “off”. If selected and turned “On” it will be red. Do a simple test and press “All On” to see all channels change to a red dot. The All off. If this operates as described you are on the right track and ready to program.

UK Reseller:
www.bladesolutions.co.uk





Star Light V3.0.3.9 (ID: Star_58:A2)

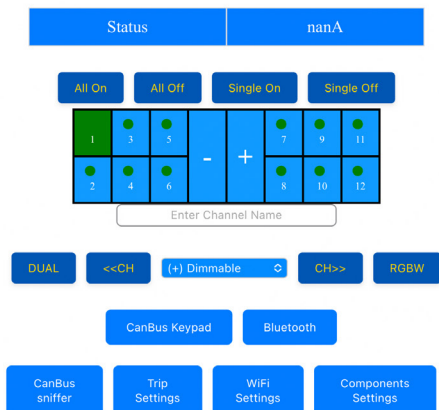

CanBus Keypad settings

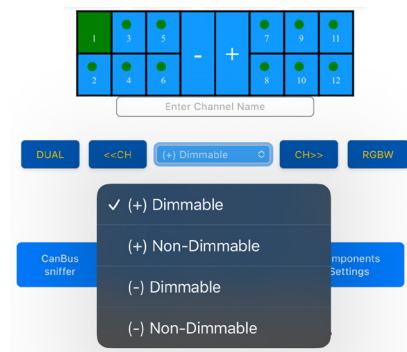
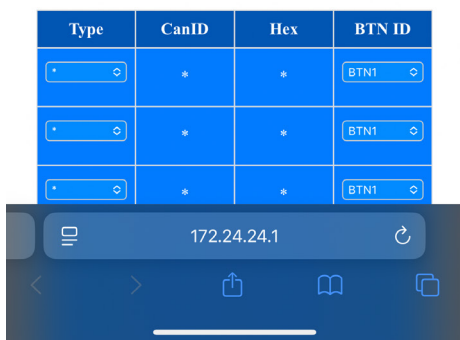

Single Channels

Firstly select each of these channels and set polarity and dimmable or non dimmable type. At the same time as this you can name the channel. This is good practice as you will then see on the screen which channels have not been programmed yet.

Then wire each of these single channels and test by selecting each channel and turning on and off on the app.

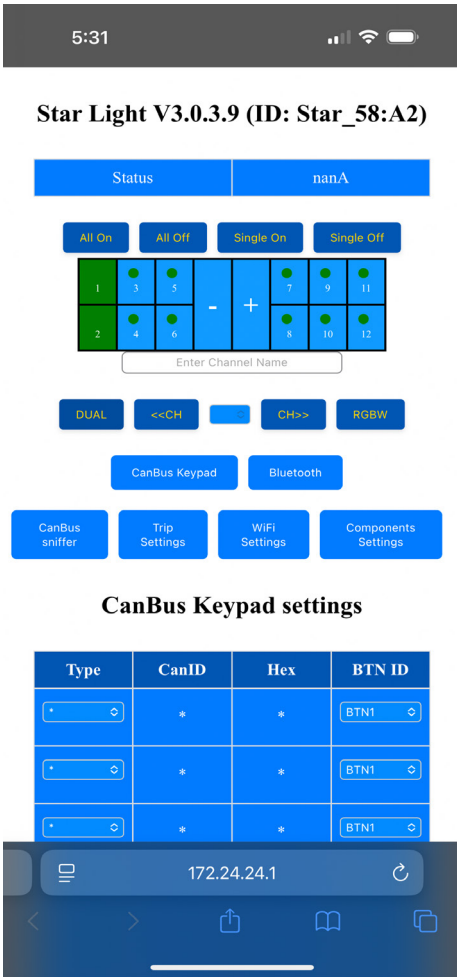

Dual Channels

These channels mean any selected switch button when pressed twice will switch between the channels, and when pressed for third time will join the channels together. This save switch real estate, labelling and cost.

Select “Dual Channels” on the App.

A block of 2 channels is shown in block colour

You can toggle through the dual channels by pressing the left or right toggle

Firstly select each of these 2 channels and set polarity and dimmable or non dimmable type. At the same time as this you can name the channel. This is good practice as you will then see on the screen which channels have not been programmed yet.



RGBW Channels

Firstly select each of these 4 channels and set to -ve Dimmable. At the same time as this you can name the channel. This is good practice as you will then see on the screen which channels have not been programmed yet.

Then, select RGBW on the screen. A block of 4 channels is shown in block colour <image of RGBW channel selection>

For the correct colour selection from this app it is important to wire the RGBW light in this order in assending channel numbers. Start with R (for red) then G (for green) then B (for Blue) then W (for White) corresponding to the increasing channel number for the block of four selected.

STAR-Light has 2 blocks of 4, STAR-Rover has 1 block of 4.

For the second block or RGBW channels on STAR-Light, touch the left or right arrow and the screen selection will change in blocks of 4. Select the block at the other end of the channels layout and repeat the process above.

Wire the channels and test by selecting each channel and turning on and off on the app.

UK Reseller:
www.bladesolutions.co.uk



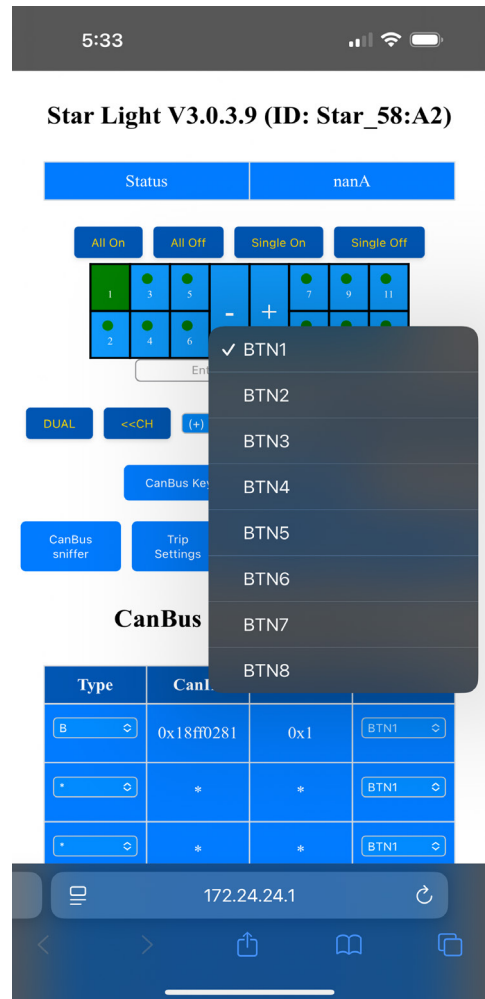
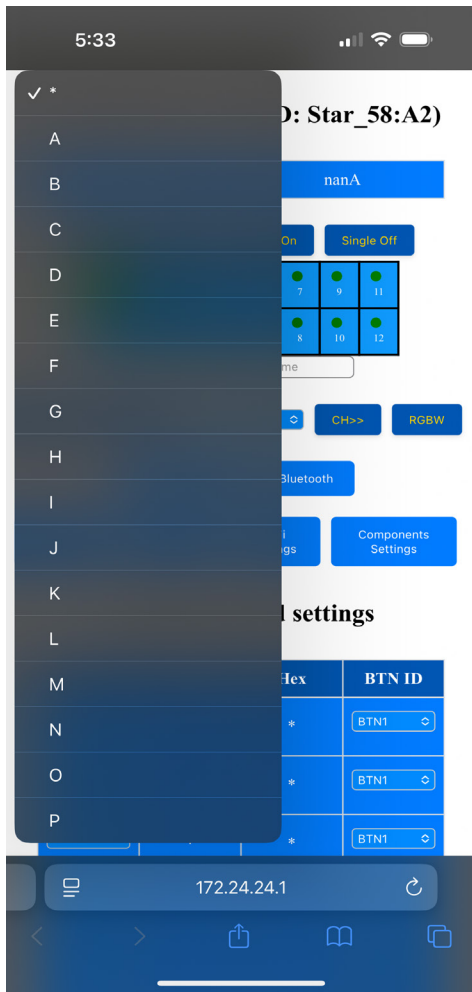

CAN Keypads

Ensure the STAR-controller is in programming mode with Left button pressed and deep blue LED on.

Select the channel number the switch(es) will activate

Then in the table select the keypad letter code. The reason for this is each keypad with a different letter has been programmed with a different CAN ID. You cant have 2 keypads with same CAN ID on same network. So if you have 4 keypads they all have to have a different letter code. They don't need to be sequential. Just different.

After selecting the keypad code, select the channel number using the convention above.

Choose CANKeypad ID from options A-P, where each letter corresponds to a specific CAN Bus keypad

Select a letter under Type, then choose the button (BTN ID) to control the selected channel.

Ensure the channel you wish to configure is highlighted green before proceeding.

As you do this the CANID and Button ID will display on the App so you know it is selected and will function.

Then if you are on a roll, just complete all wired cannels.

Then take out of programming mode by pressing the right button for 10 seconds. Then test the CAN Keypads ! Impressive hey!

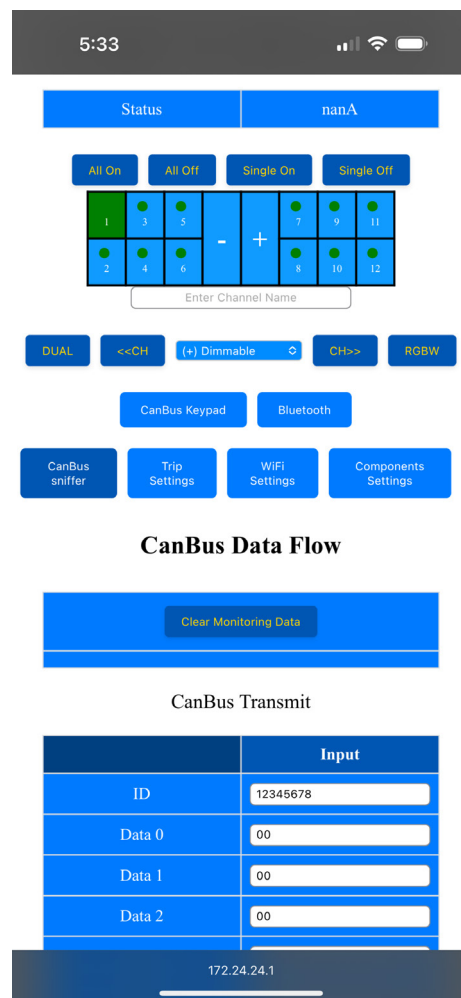
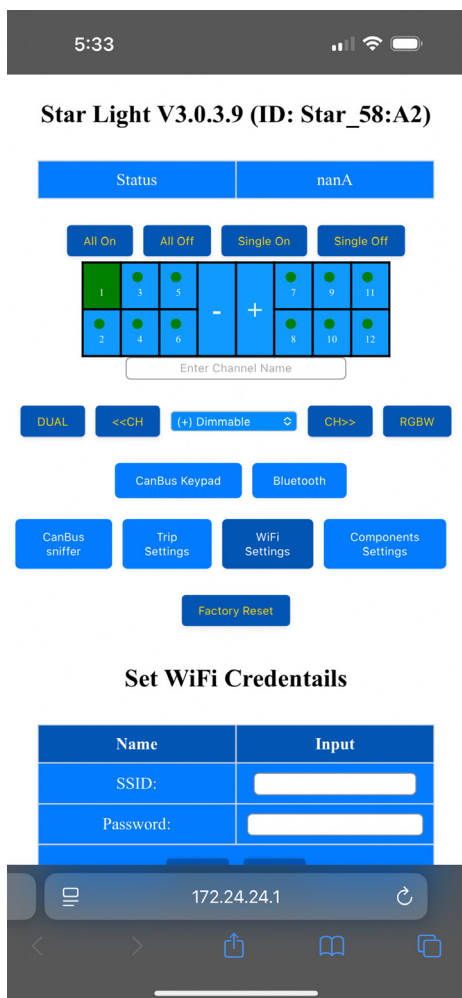

BLUETOOTH Switches

Ensure the STAR-controller is in programming mode with Left button pressed and deep blue LED on.

Select "Scan for bluetooth"

Select the channel number the switch(es) will activate

The press the bluetooth buttons that will activate that channel.

As you press each button the UUID will display on the App so you know it is selected and will function.

Then if you are on a roll, just complete all wired cannels.

Then select "Stop Bluetooth Scan"

Then take out of programming mode by pressing the right button for 10 seconds.

Then test the bluetooth switching ! Impressive hey!

Clearing Bluetooth Settings

To clear the Bluetooth settings for a specific channel:

- Ensure the desired channel is selected and highlighted green.
- Press the Erase BLE Data button.

This will remove all selected Bluetooth devices associated with that channel.

Firmware Update OTA (Over The Air)

(step 1) save the Star-XXX VX.X.X.X.bin to a local directory. This is on your phone.

(step 2) Turn on Star Product by pressing left button and join the WiFi SSID

(step 2.1) Open a web browser, and visit 127.24.24.1/update

(step 2.2) Click "Start OTA" button, and the screen turns black (Do not press on screen again, otherwise it goes out of OTA)

(step 2.3) Click "Choose File" to select the Star-XXX VX.X.X.X.bin which you saved just now

(step 2.4) Click "Update" button, and wait for rebooting complete

(step 2.5) Once the system is rebooted, please check the version number (shown in top center) is "Star-XXX VX.X.X.X"

FIRMWARE UPGRADES

On both the products page with the STAR controllers and the Support Pages are blocks for Firmware Updates. This is a “No Charge” purchase and after purchase the firmware is downloadable.

Introduction

A Controller Area Network (CAN bus) is a robust vehicle bus standard designed to allow microcontrollers and devices to communicate with each other's applications without a host computer. Its reliability, however, is critically dependent on the physical wiring of the network.

This guide covers the essential principles of CAN bus wiring, focusing on the two most critical aspects: network termination and drop cable (dropper) length. Following these rules is essential for a stable and error-free network.

Core Network Components

- **Backbone:** The main communication line of the network. It's a single, continuous cable that forms the primary data path.
- **Terminating Resistor:** A 120-Ohm (Ω) resistor placed at each of the two physical ends of the backbone to prevent signal reflection.
- **Drop Cable (or Dropper/Stub):** A shorter cable that connects an individual device (like a controller or sensor) to the main backbone.
- **T-Connector:** A three-way connector used to attach a drop cable to the backbone without cutting or splicing the main line.

Principle 1: Network Termination is Mandatory

The single most important rule in CAN bus wiring is termination.

Why is it necessary?

A CAN bus transmits high-frequency electronic signals. When these signals reach the end of a wire, they can "bounce" or reflect back down the cable, much like a wave hitting a seawall. This reflected signal interferes with new, incoming signals, corrupting the data and causing communication errors.

A terminating resistor absorbs the signal energy at the end of the line, preventing these reflections.

The Rule of Two

- A CAN bus network must have exactly two 120 Ω terminating resistors.
- One resistor must be placed at each physical end of the backbone.
- Having zero, one, or more than two resistors will cause network failure.

Correct Termination:



Incorrect Terminators:

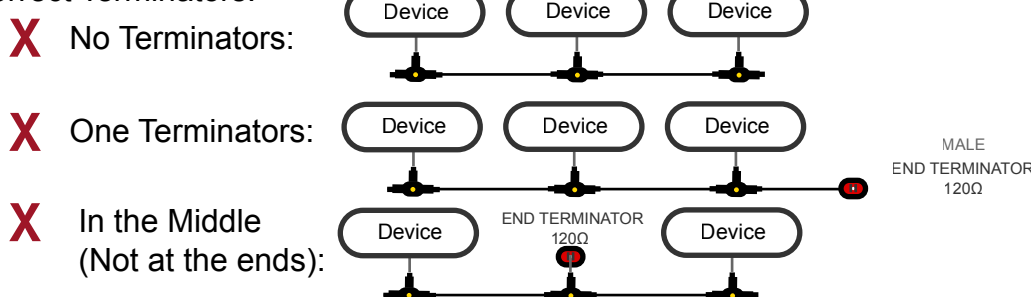

Principle 2: Keep Drop Cables (Droppers) Short

While the backbone can be quite long (up to 40 meters for STAR range), the length of the cables that drop from the backbone to each device is strictly limited.

Why is drop length critical?

Each drop cable acts as an unterminated branch, or "stub," off the main backbone. On these stubs, signal reflections can still occur. While minor reflections from very short stubs are tolerable, longer stubs create significant reflections that can corrupt data on the main backbone. The longer the stub, the more destructive the reflection.

The Drop Length Rule

The maximum allowable length for a drop cable depends on the network's data rate (baud rate). For the most common standards:

- NMEA 2000: Maximum cumulative drop length is 78 meters, but no single drop cable should exceed 6 meters (20 feet). Best practice is to keep them as short as possible, 30-50cm is perfect.

As a universal rule of thumb: Always use the shortest drop cable possible for your installation.

Good vs. Bad Drop Length:

**Summary of Best Practices**

- Use Two 120Ω Resistors: One at each physical end of the backbone. No exceptions.
- Build a Linear Backbone: Connect devices via T-connectors. Avoid star-shaped layouts where multiple backbones branch from a central point.
- Keep Drop Cables Short: Adhere to the standard for your protocol (e.g., max 6m for NMEA 2000). The shorter, the better.
- Ensure Good Connections: Use high-quality, protocol-approved connectors. Safiery's CAN connectors and cabling is NMEA 2000 Approved. DONT splice wires directly.
- Centralize Power: Insert 12V power near the middle of the backbone to ensure even voltage distribution to all devices.

By following these fundamental wiring principles, you can create a robust and reliable CAN bus network that will perform as expected.

Drawing 1: Simple Linear Backbone

This is the most common and ideal layout. It's simple, efficient, and easy to troubleshoot.

Description:

- A single, straight backbone connects all devices.
- A 120-Ohm terminator is placed at each end.
- Power is inserted near the middle of the backbone to ensure even voltage distribution.
- The drop cables are short and connect each device to the main line.

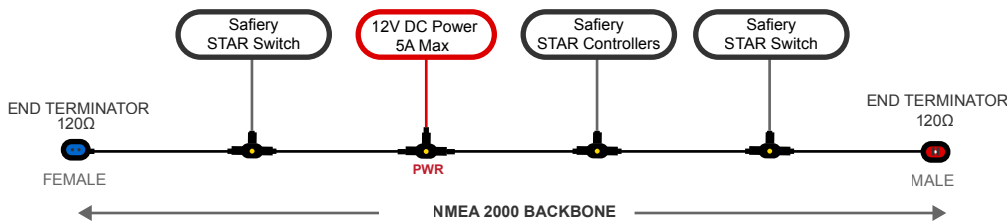

Drawing 2: "L-Shaped" Backbone with Varied Drop Lengths

This layout is more realistic for installations where the backbone needs to navigate around corners, like from a helm console down into an engine room or bilge area.

Description:

- The backbone cable itself can bend and be routed as needed. The key is that it remains a single, continuous electrical path.
- The terminators are still at the physical ends of the entire backbone, regardless of its shape.
- This example clearly shows different drop cable lengths, all of which are acceptable as long as none exceed the 6-meter limit.

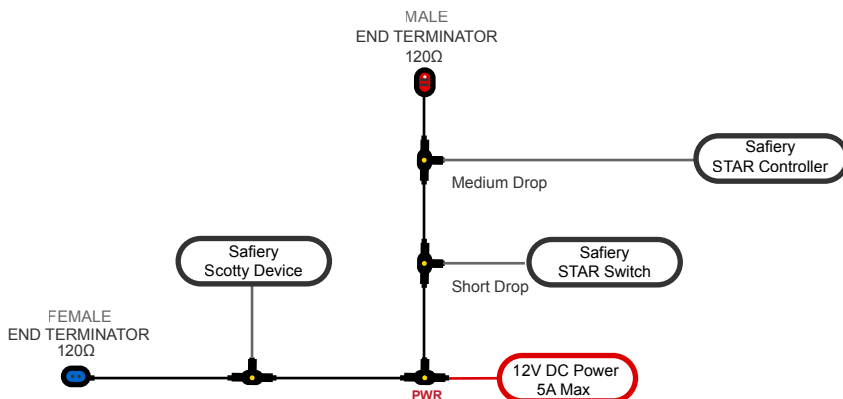

- The backbone is extended to reach devices that are far apart.
- With a longer backbone and more devices, placing the power insertion point near the electrical center is even more important to prevent voltage drop at the far ends of the network.
- Even with more devices, the core rule of two terminators at the ends remains absolute.

Common Mistakes to AVOID

This drawing shows incorrect layouts. Understanding why they are wrong is as important as knowing the right way.

Description:

- Mistake A (Star Network): This is the most common installation error. You cannot simply branch the backbone out in multiple directions from a central point. Each branch would need terminators, resulting in too many on the network and causing signal chaos.
- Mistake B (Excessive Drop Length): This drop cable exceeds the 6-meter maximum, which can cause signal reflections and data errors that are very difficult to diagnose.
- Mistake C (Missing Terminator): Without a terminator at this end, signals will reflect back down the wire, corrupting all network data.

*** MISTAKE A: Star / Multiple Backbones ***

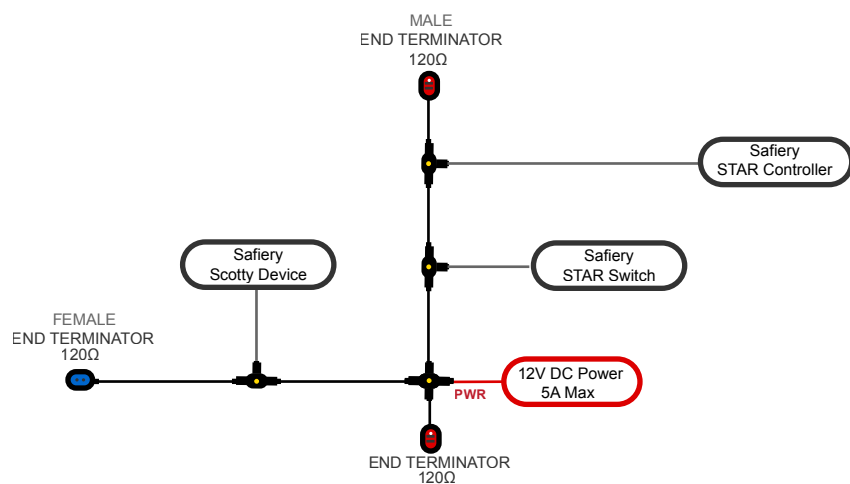

X More than 2 terminators

*** MISTAKE B & C ***

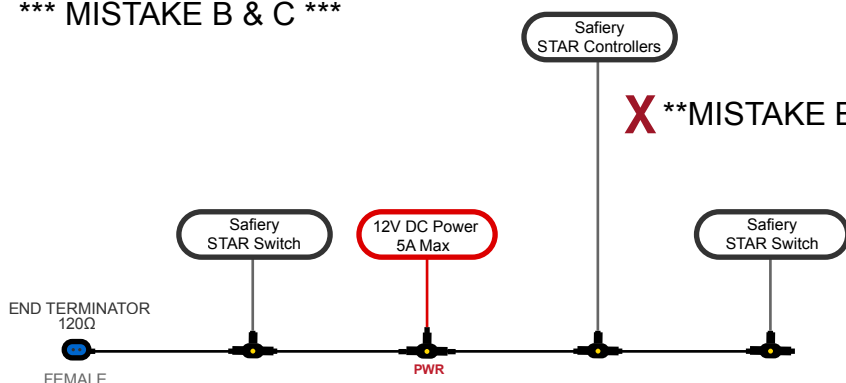

X **MISTAKE B: Drop > 6 meters.**

X **MISTAKE C: No Terminator!**

UK Reseller:
www.bladesolutions.co.uk

BLADE
SOLUTIONS

Right Angle Tee Pieces can be used to form a backbone when only 2-3 components spread apart

CAN Wiring - A Practical Reference Guide

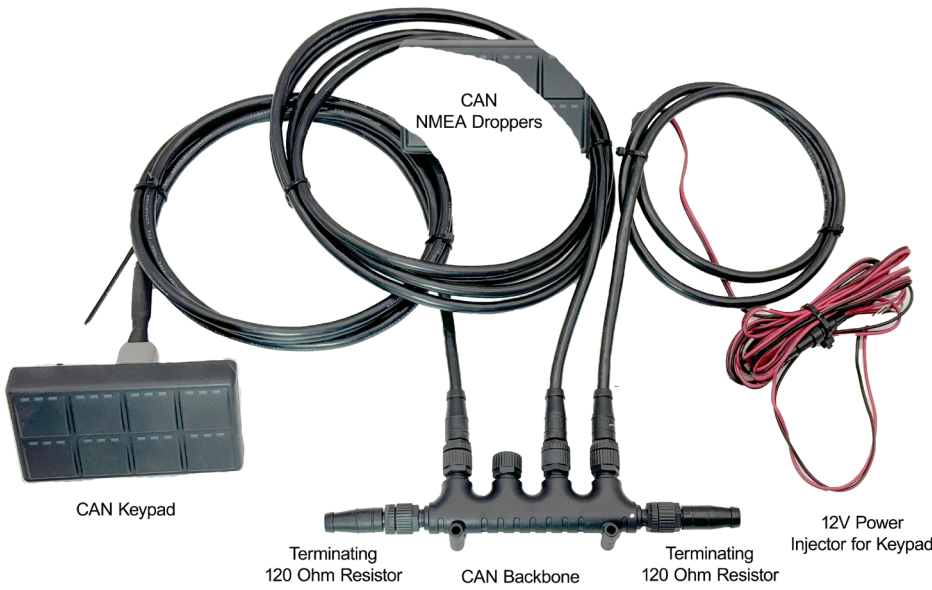

NMEA	
	NMEA 2000 Backbone/Drop Cable (2 m/6 ft) AUD49.00
	NMEA 2000 Backbone/Drop Cable (5 m/17 ft) AUD55.00
	NMEA 2000 Backbone/Drop Cable (10 m/32 ft) AUD65.00
	NMEA 2000 Backbone/Drop Cable (0.3 m/1 ft) AUD39.00
	NMEA 2000 Backbone/Drop Cable, Right Angle (2 m/6 ft) AUD49.00
	NMEA 2000 Terminators, Male and Female Pair AUD55.00
	NMEA 2000 T-connector, 1 Port AUD39.00

Home > STARSHIP Digital Switching System > NMEA Cable Kit Starter Pack 2m Backbone and Droppers



NMEA Cable Kit Starter Pack 2m Backbone and Droppers

SKU NMEA-Kit-B
AUD179.00

Items included in Kit Shown below

Show Bundles

Quantity - 1 +

Add to cart

Note: The price added to the cart is exclusive of GST.

Compare

Add to wishlist

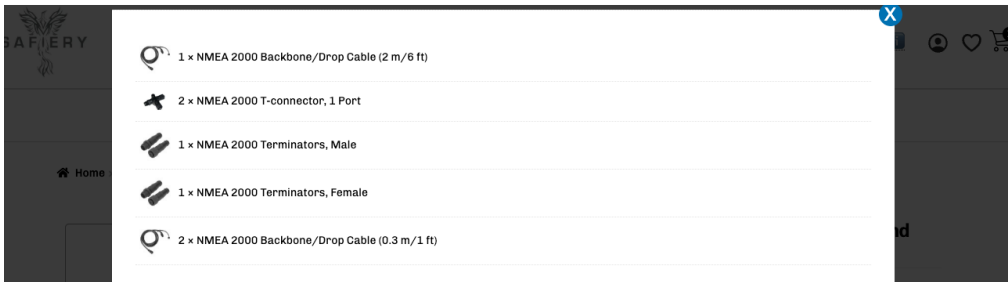

Home > STARSHIP Digital Switching System > NMEA 2000 T-connector, 1 Port



NMEA 2000 T-connector, 1 Port

SKU 010-11078-00
AUD39.00

Quantity - 1 +

Add to cart

Note: The price added to the cart is exclusive of GST.

Compare

Add to wishlist

UK Reseller:
www.bladesolutions.co.uk



STAR-Power Currently requires a NMEA to open ended wires that connect the White and Blue Wires to the CAN pins at bottom of STAR-Power LH plug (Marked) CAN L is Blue and CAN Hi is White In this same cable are Red and Black wires. These can be used as power injection for CAN Keypads. Alternatively a separate power injector can be ordered and used elsewhere on CAN network.

CAN Wiring - Quality Waterproof NMEA Connections

Safiery uses NMEA approved 5 pin double shielded cable and connectors. They do seem expensive but will last a lifetime and eliminate CAN errors.

Feature / Attribute	Safiery STAR Range NMEA Approved Double Shielded	System B (CAT 6 Cable, RJ45 Plugs)
Physical Robustness & Durability	Superior. Connectors are typically circular M12-style with screw threads. They are designed to resist vibration and provide a secure, locked connection that cannot be accidentally unplugged. High IP ratings (IP67/IP68) are common, making them dust-tight and fully waterproof.	Poor. RJ45 connectors were designed for a stable office environment. The plastic locking tab is notoriously fragile and easily breaks, leading to intermittent connection loss. They offer no inherent protection against moisture, dust, or vibration unless placed in a secondary ruggedized enclosure.
Electrical Noise Immunity (EMI)	Excellent. The double-shielded approach is best practice. The inner foil shield protects the CAN Hi/Lo data pair from noise generated by the adjacent power wires. The outer braided shield protects the entire bundle from powerful external noise sources (motors, pumps, inverters, VHF radios).	Good, but with a weak link. CAT 6 cable itself has excellent design for noise rejection due to the tight twisting of its internal pairs. However, the RJ45 connector is a significant weak point. It is difficult to maintain a continuous 360-degree shield through the plastic plug, making the connection point vulnerable to EMI ingress/egress.
Power Delivery Capability	Excellent. The cable is designed for its purpose, using appropriately sized wire gauges (e.g., 16-18 AWG) for the 12V positive and negative conductors. This minimizes voltage drop over the length of the network, ensuring all devices receive stable power.	Very Poor / Potentially Dangerous. CAT 6 uses very thin wires (typically 23 or 24 AWG). Attempting to draw significant current through these thin wires over any distance will cause severe voltage drop, starving devices of power and potentially creating a fire hazard. This is the single biggest electrical drawback of this approach.
Industry Standardization & Interoperability	Industry Standard. Your system uses the NMEA 2000 connector standard. This means your devices are plug-and-play compatible with thousands of certified marine products from hundreds of manufacturers, including chartplotters, sensors, and displays.	Proprietary / Non-Standard. Using RJ45 for CAN bus in a marine environment is a non-standard, proprietary choice. This locks the customer into the competitor's ecosystem. Their devices cannot be connected to a standard NMEA 2000 network without a special adapter, and interoperability is not guaranteed.

UK Reseller:
www.bladesolutions.co.uk

The Future Arrives Instantly Compatible: Apple, Google and Samsung

DAME DESIGN | Nominated
AWARD | 2024

victron energy
BLUE POWER

Victro Cerbo Wired and Wireless Hub Smart Solar MPPT Multiplus II

DIGITAL SWITCHING PAGE

Touch for Digital Switching Pages

POWER AND ENERGY PAGE

TANK & TEMP PAGE

Technical Displays with Configuration and Setup

STAR-Switches
Dimming & Dual Colour
Battery Wireless

STAR-Switch
8 or 12 button
Interchangeable Icons

STAR-Switch
6 Wired Inputs
to Bluetooth or CAN

STAR-Power
12 Channels 6 x 10A 6 x 30A
Bluetooth / CAN

STAR-Light
12 Channels 10A
Bluetooth / CAN + RGBW

STAR-Rover
4 Channels 15A
Bluetooth / CAN IP65

Now in 24V

Now in 24V

UK Reseller:
www.bladesolutions.co.uk

Google Gemini AI can natively interrogate Safiery Star Controllers



"Gemini, set a lighting scene that compliments the sunset: slowly increase lighting levels from a low dim to bright after sunset."

No need to know name of lights - conversational!



User Chooses Native Home Control App for Comfort and Convenience

OPEN Blockchain Encrypted Wireless Network using Safiery STAR Controllers are BOTH MATTER Compliant Plus operate with Bluetooth, CAN, NMEA, Victron and show power & batteries on Smart Displays.

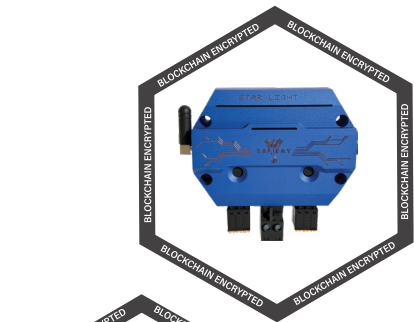

"Hi Skipper, batteries 80%, water 50%, Temp falling, solar forecast is good, Putting heating & hotwater on early"

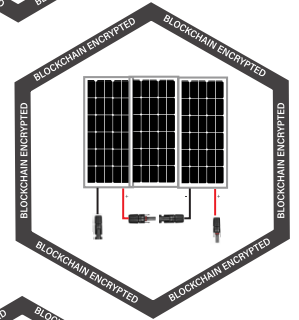

MULTIMEDIA



Secure - NOT Proprietary - Open System - AI Built-in already



UK Reseller:
www.bladesolutions.co.uk



GET IN TOUCH

QLD HQ:
Safiery Pty Ltd
45/8 Distribution Court,
Arundel QLD 4214
+61(07) 2102 25 53
service@safiery.com

SUPPORT

Contact: sales@safiery.com
Phone: (07) 210 22 553

SOCIALS

[Instagram.com/safiery.global](https://www.instagram.com/safiery.global)
[youtube.com/@Safiery](https://www.youtube.com/@Safiery)

